

Beispiele Elektrischer Felder (1)

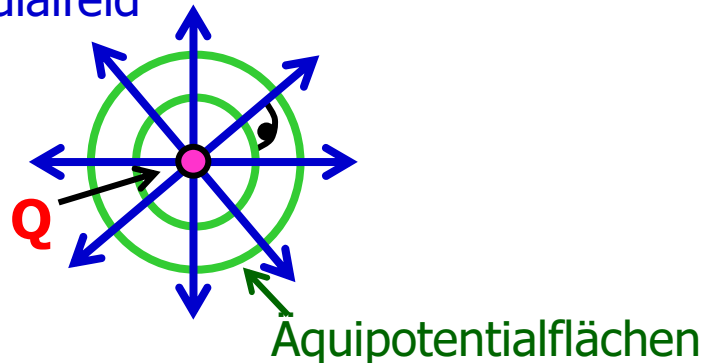

Beispiel 1: Feld des elektrischen Monopols

Radialfeld



$$\vec{E} = \frac{1}{4\pi\epsilon_0} \frac{Q\vec{r}}{r^3}$$

$$\phi = \frac{1}{4\pi\epsilon_0} \frac{Q}{r}$$

Beispiel 2: Feld des elektrischen Dipols

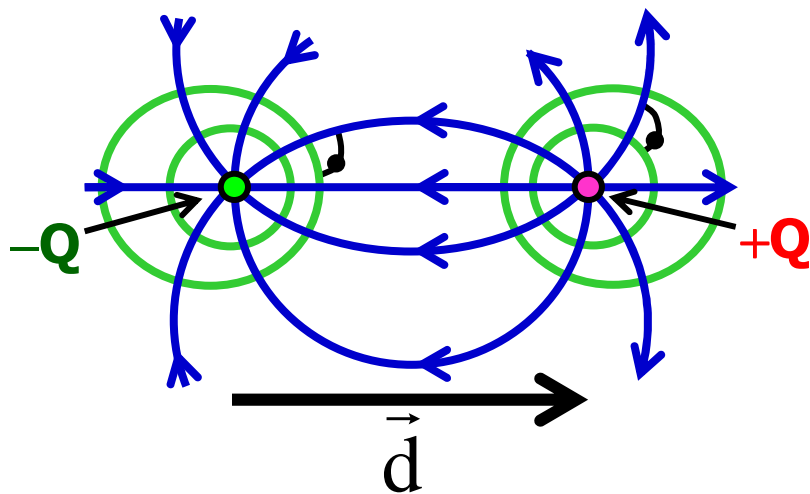

Elektrisches Dipolmoment:

$$\vec{p}_e = Q \cdot \vec{d}$$

$r \rightarrow \infty$: Dipol \rightarrow Monopol der Ladung $Q - Q = 0$

$$\vec{E}(r \rightarrow \infty) \propto \frac{1}{r^3}$$

$$\phi(r \rightarrow \infty) \propto \frac{1}{r^2}$$

Beispiele Elektrischer Felder (2)



Beispiel 3: Feld zweier gleicher Ladungen

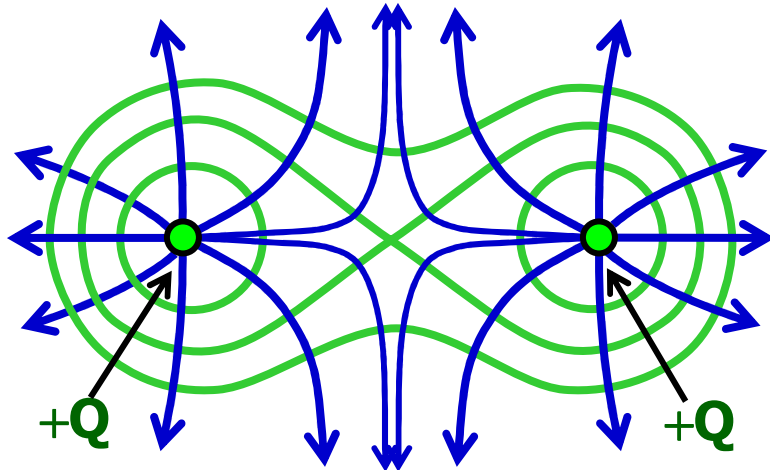

$r \rightarrow \infty$: \rightarrow Monopol der Ladung $2Q$

$$\vec{E}(r \rightarrow \infty) = \frac{1}{4\pi\epsilon_0} \frac{2Q\vec{r}}{r^3}$$

$$\phi(r \rightarrow \infty) = \frac{1}{4\pi\epsilon_0} \frac{2Q}{r}$$

Beispiel 4: Feld eines elektrischen Quadrupols

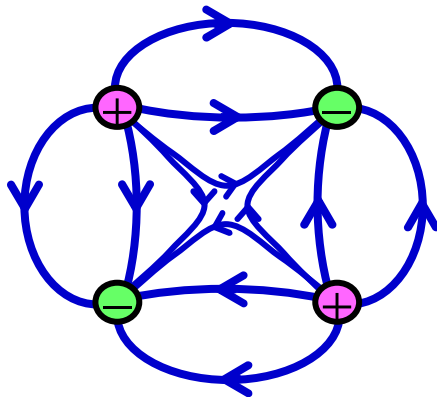

$$\vec{E}(r \rightarrow \infty) \propto \frac{1}{r^4}$$

$$\phi(r \rightarrow \infty) \propto \frac{1}{r^3}$$

Feld eines Plattenkondensators

Beispiel 5: Homogenes Feld

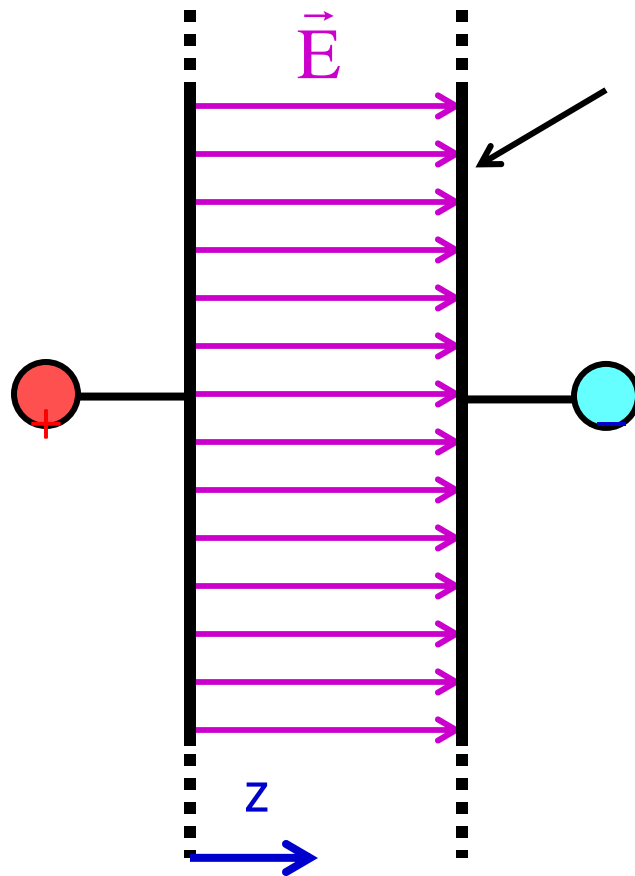

Plattenkondensator

Flächenladung:

$$\sigma = \frac{dQ}{dA}$$

$$\vec{E} = \frac{\sigma}{\epsilon_0} \cdot \vec{e}_z = \text{const.}$$

$$\phi = -\frac{\sigma}{\epsilon_0} \cdot z$$

Elektrischer Fluss



$$\vec{E}(\vec{r}) = \int d^3R \frac{\rho(\vec{R})}{4\pi\epsilon_0} \cdot \frac{\vec{r} - \vec{R}}{|\vec{r} - \vec{R}|^3}$$

↓ Gaußscher Satz

$$\text{div } \vec{E} = \frac{\rho}{\epsilon_0}$$

↑ Gaußscher Satz

$$\Phi = \oint_A \vec{E} \cdot d\vec{A} = \frac{Q}{\epsilon_0}$$

Gaußsches Gesetz

elektrischer Fluss durch A

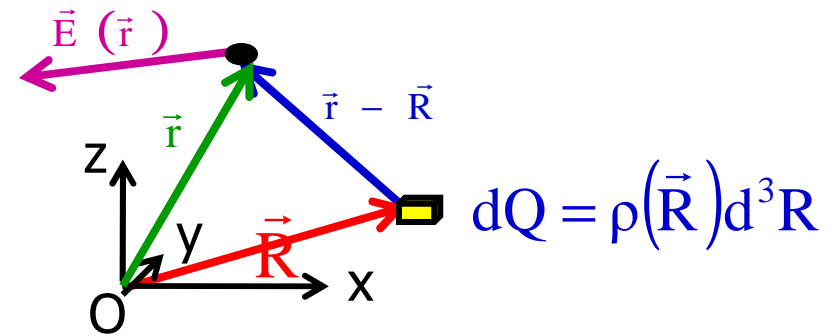

Ladungen sind die Quellen ($\rho > 0$) bzw. Senken ($\rho < 0$) des elektrischen Feldes

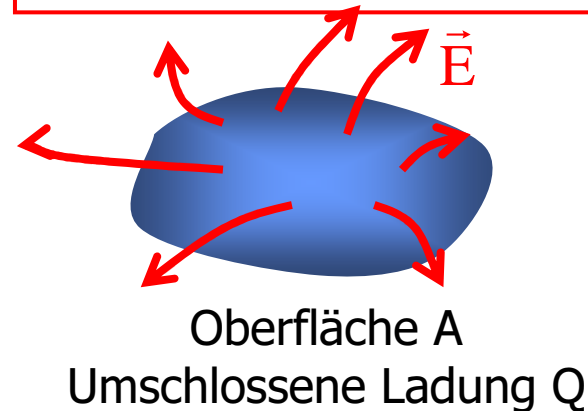

1.3. Elektrostatisches Potential



Definition: Die Potentialdifferenz zwischen zwei Punkten heißt elektrische Spannung U

$$U_{12} = \phi_1 - \phi_2 = \int_{\vec{r}_1}^{\vec{r}_2} \vec{E} d\vec{s}$$

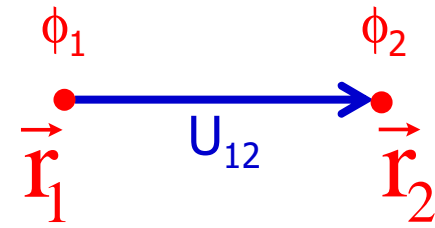

Bewegung einer Testladung q durch U_{12} :

$$\Delta E_{\text{pot}} = - \int_{\vec{r}_1}^{\vec{r}_2} q \vec{E} d\vec{s} = -q U_{12} \quad \Delta E_{\text{kin}} = +q U_{12}$$

Einheiten:

$$[U] = \text{V} = \text{Volt}$$

$$[E] = \text{V m}^{-1}$$

$$1 \text{ V} = 1 \text{ kg m}^2 \text{ A}^{-1} \text{ s}^{-3}$$

$$1 \text{ V A s} = 1 \text{ kg m}^2 \text{ s}^{-2} = 1 \text{ J} = 1 \text{ W s}$$

Punktladung im homogenen Feld



$$\begin{aligned}\vec{F} &= q \cdot \vec{E} = q \cdot E \cdot \vec{e}_z \\ &= m \cdot \ddot{z} \cdot \vec{e}_z\end{aligned}$$

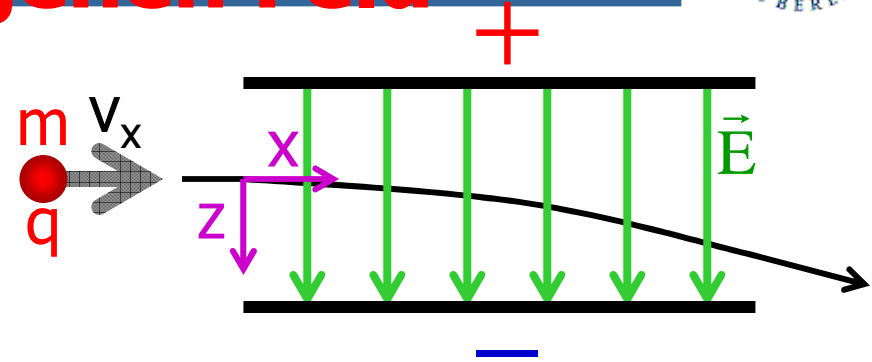

$$\Rightarrow \begin{cases} \dot{v}_z = \frac{qE}{m} \Rightarrow v_z = \frac{qE}{m} t, & z = \frac{1}{2} \frac{qE}{m} t^2 \\ \dot{v}_x = 0 \Rightarrow v_x = \text{const.}, & x = v_x t \end{cases}$$

$$\Rightarrow z(x) = \frac{qE}{2m v_x^2} \cdot x^2 \quad \text{Parabel}$$

Beschleunigung im homogenen Feld

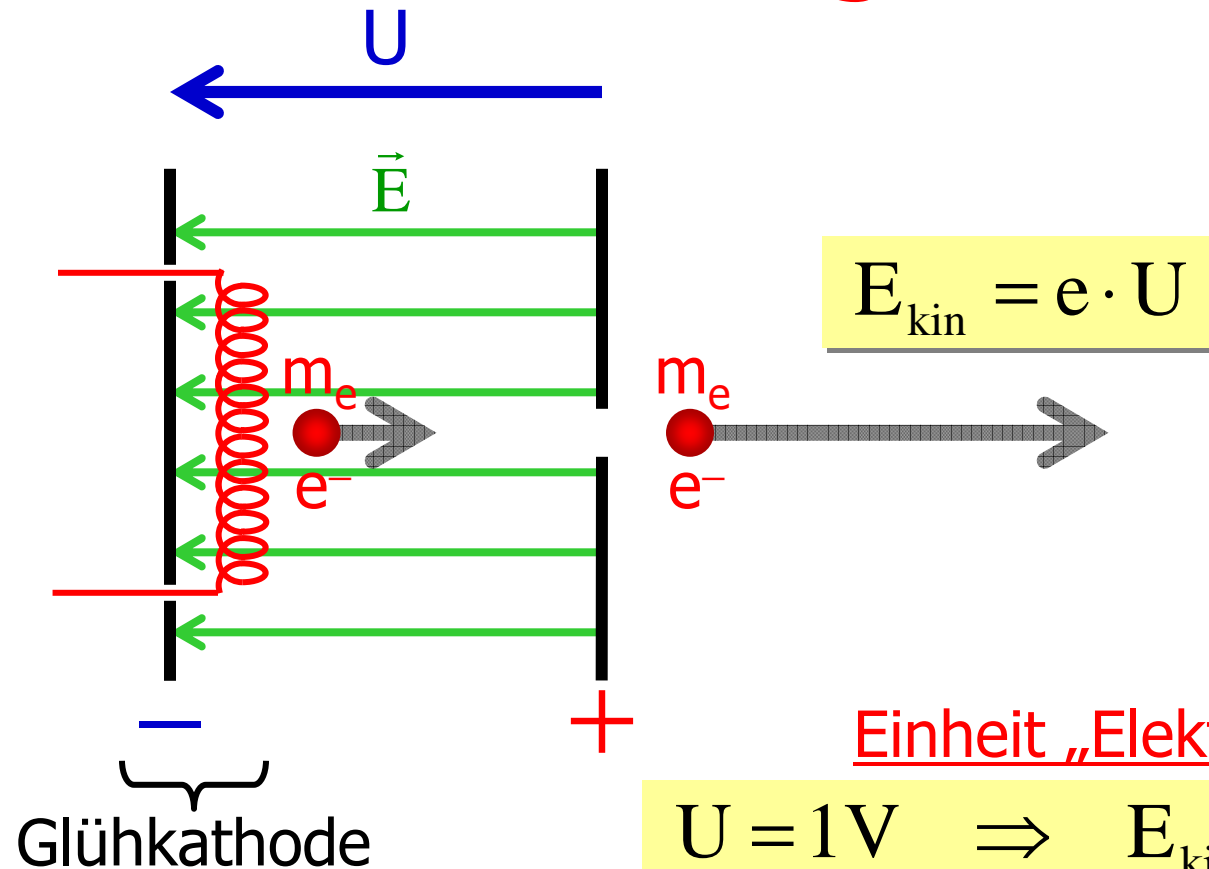

Einheit „Elektronenvolt“:

$$U = 1\text{V} \Rightarrow E_{\text{kin}} = e \cdot 1\text{V} \equiv 1\text{eV}$$

$$1\text{eV} = 1,602 \cdot 10^{-19}\text{J}$$