

Experimente mit einzelnen Ionen

Einzelne Ladungen können nicht allein durch statische elektrische Felder stabil im Raum gehalten werden (Earnshaw-Theorem).

- ➔ Elektrische Wechselfelder (Paul-Falle)
- ➔ Elektrische und magnetische Felder (Penning-Falle)

Eine Paul-Falle (Nobelpreis 1989) besteht aus zwei parabolischen Elektroden und einer Ringelektrode:

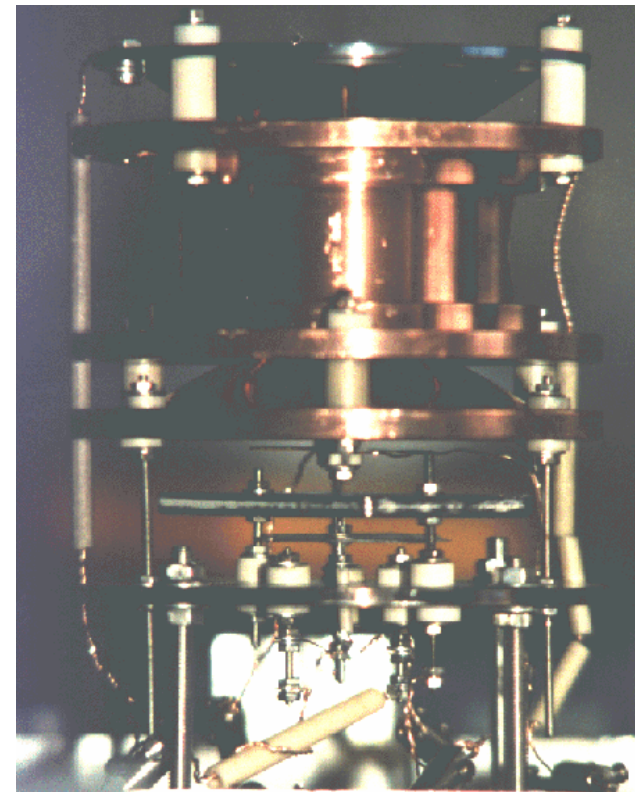
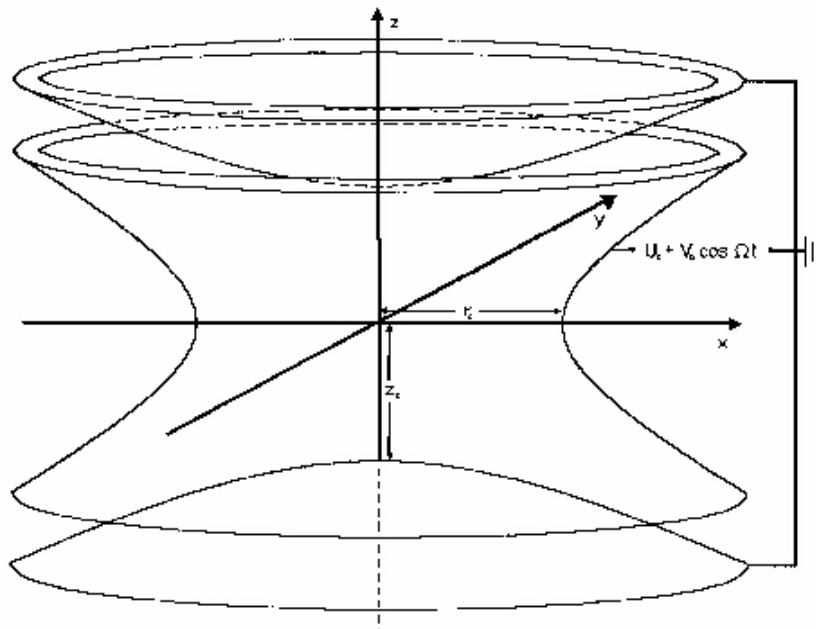

Wird eine Gleichspannung U_{dc} und eine Wechselspannung V_{ac} mit der Frequenz Ω angelegt, so hat das Potential nahe des Fallenzentrum die Form:

$$\Phi = \frac{(U_{dc} + V_{ac} \cos(\Omega t))(r^2 - 2z^2 + 2z_0^2)}{r_0^2 + 2z_0^2}$$

Wobei r_0 und z_0 den Abstand vom Fallenzentrum zu den Elektroden angibt.

Das Potential ist harmonisch und stellt für einen bestimmten Zeitpunkt eine rücktreibende Kraft in einer Dimension dar:

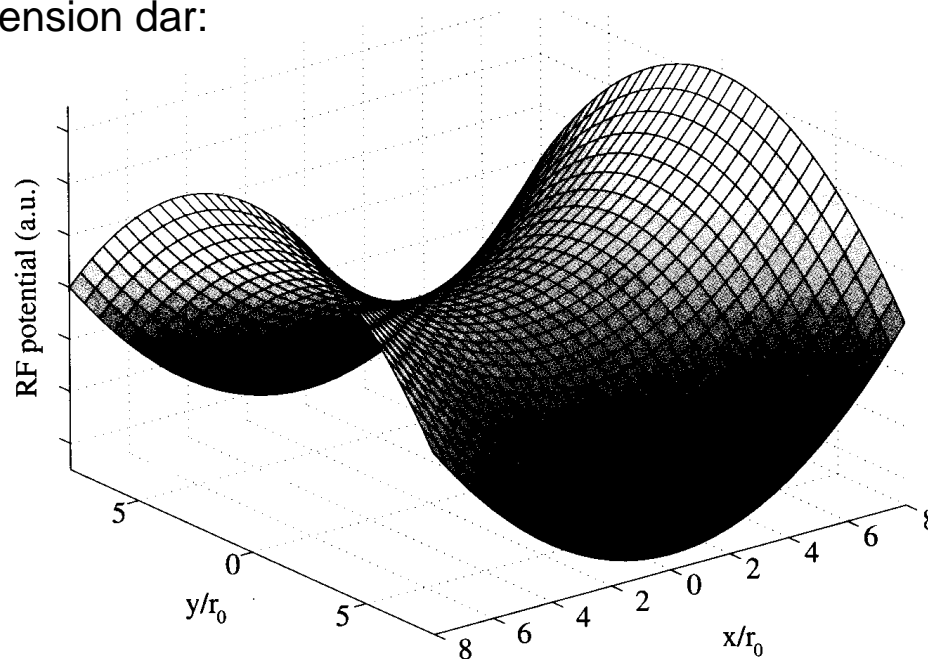

Die Trägheit des gefangenen Teilchens verhindert, dass das Teilchen in der anderen Richtung aus der Falle getrieben wird, bevor $\cos(\Omega t)$ das Vorzeichen wechselt!

Für bestimmte Ω \rightarrow rücktreibende Kraft in allen drei Raumrichtungen

Bewegungsgleichungen in der Paul-Falle:

$$m \frac{d^2}{dt^2} \begin{pmatrix} x \\ y \\ z \end{pmatrix} = \frac{2q(U_{dc} - V_{ac} \cos(\omega t))}{r_0^2 + 2z_0^2} \begin{pmatrix} -x \\ -y \\ 2z \end{pmatrix}$$

Mit der Transformation:

$$\tau = 1/2\omega$$

$$a_x = a_y = -a_z/2 = \frac{4qU_{dc}}{mr_0^2\Omega^2}$$

$$q_x = q_y = -q_z/2 = \frac{2qV_{ac}}{m\Omega^2 r_0^2}$$

folgt:

$$\frac{d^2 u_i}{d\tau^2} + (a_i + 2q_i \cos(2\tau)) u_i = 0$$

mit $i = x, y, z$

Mathieu'sche Differentialgleichung

Falls $a_i, q_i \ll 1$ (gilt üblicherweise) ist die Lösung:

$$u_i(t) = A_i \cos(\Omega_i t + \phi_i) \left[1 + \frac{q_i}{2} \cos(\omega t) \right]$$

mit $\Omega_i \approx \frac{\omega}{2} \left(a_i + \frac{q_i}{2} \right)$

Die Lösung besteht aus einer schnellen Bewegung der Frequenz ω (Mikrobewegung) und einer langsamen Bewegung (Makrobewegung) in einem harmonischen Potential.

Im Fallenzentrum verschwindet die Mikrobewegung!

Linear Ion Traps Courtesy: Rainer Blatt, University Innsbruck

Paul mass filter

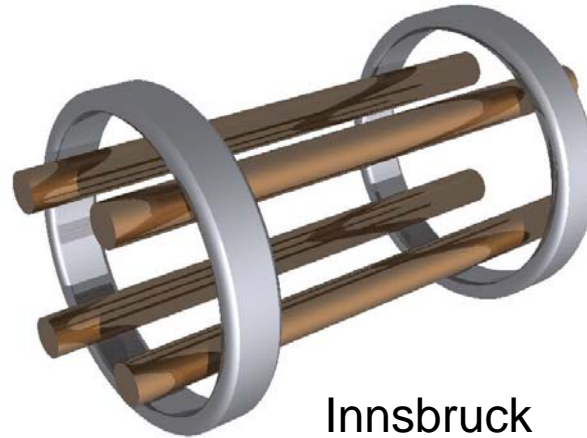
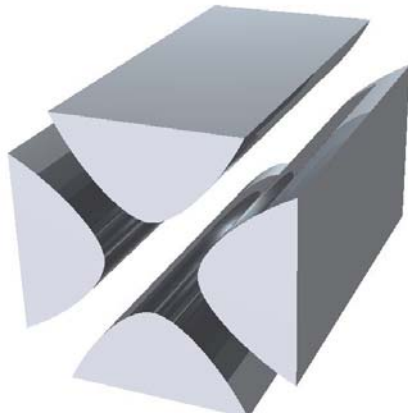

Innsbruck
Ann Arbor

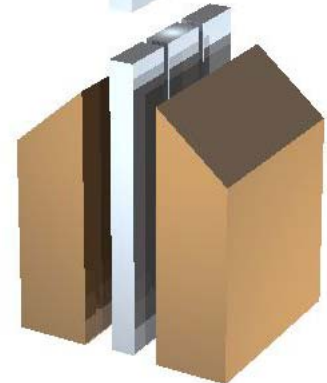
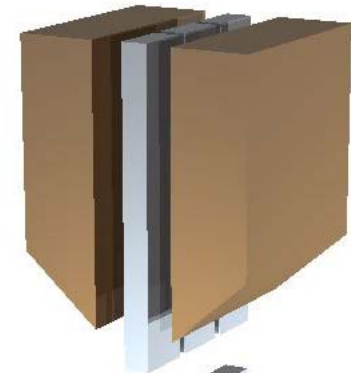

München

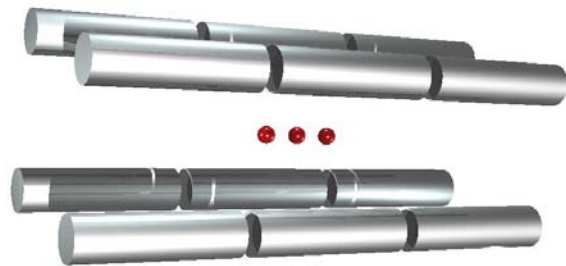

Boulder, Mainz, Aarhus

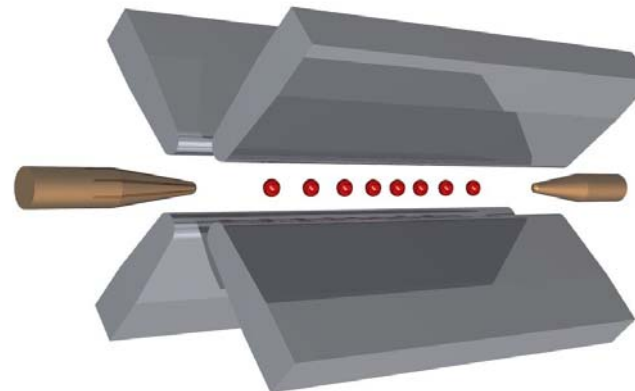

Innsbruck, Oxford

Innsbruck linear ion trap (2000)

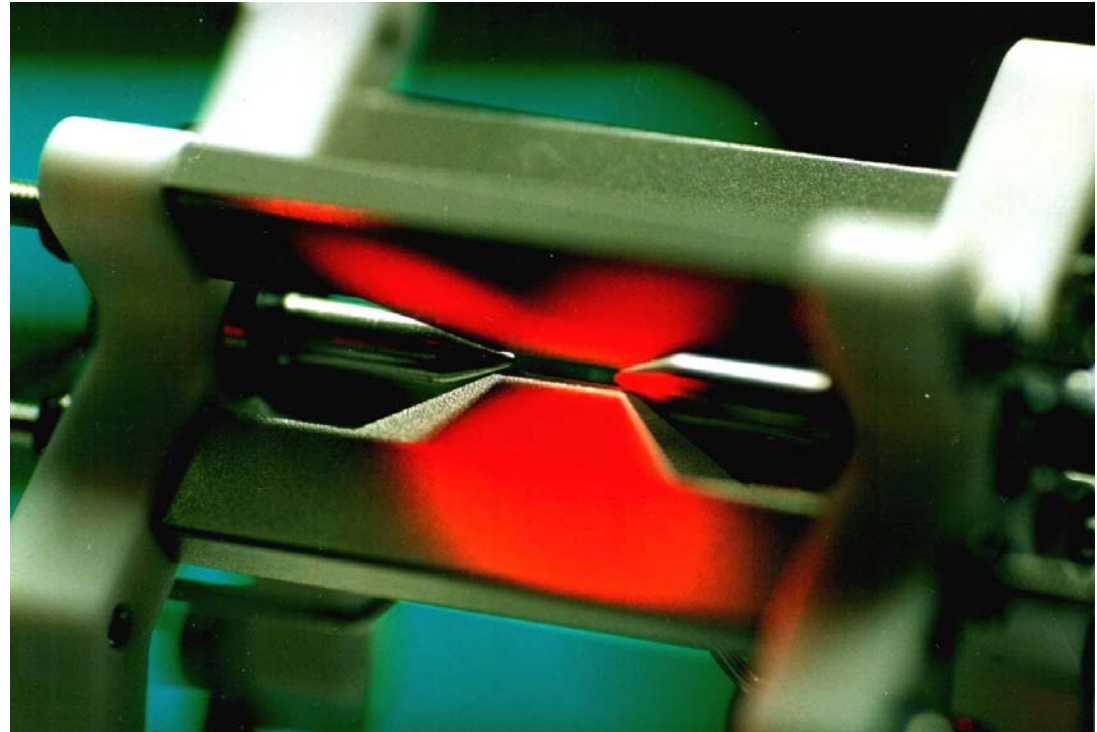
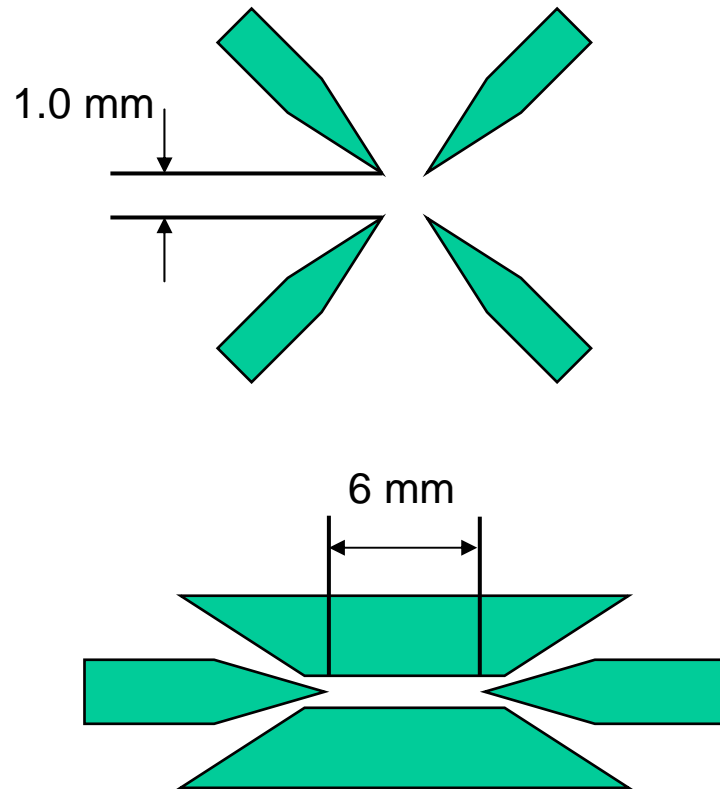

$$\omega_z \approx 0.7 - 2 \text{ MHz} \quad \omega_{x,y} \approx 1.5 - 4 \text{ MHz}$$

String of $^{40}\text{Ca}^+$ ions in a linear Paul trap

row of qubits in a linear Paul trap forms a quantum register

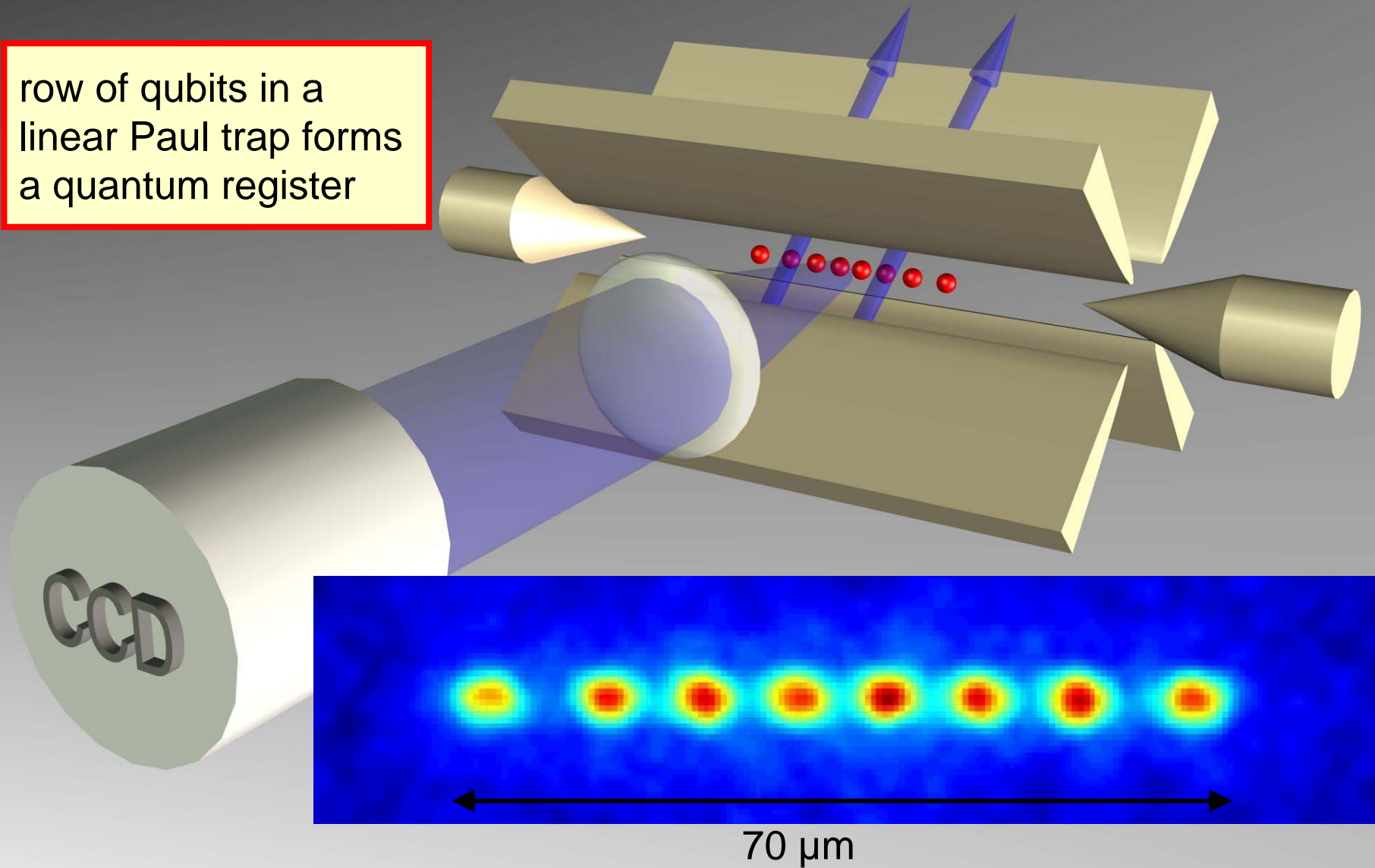

Level scheme of Ca^+

qubit on narrow S - D
quadrupole transition

$$\tau \approx 1\text{s}$$

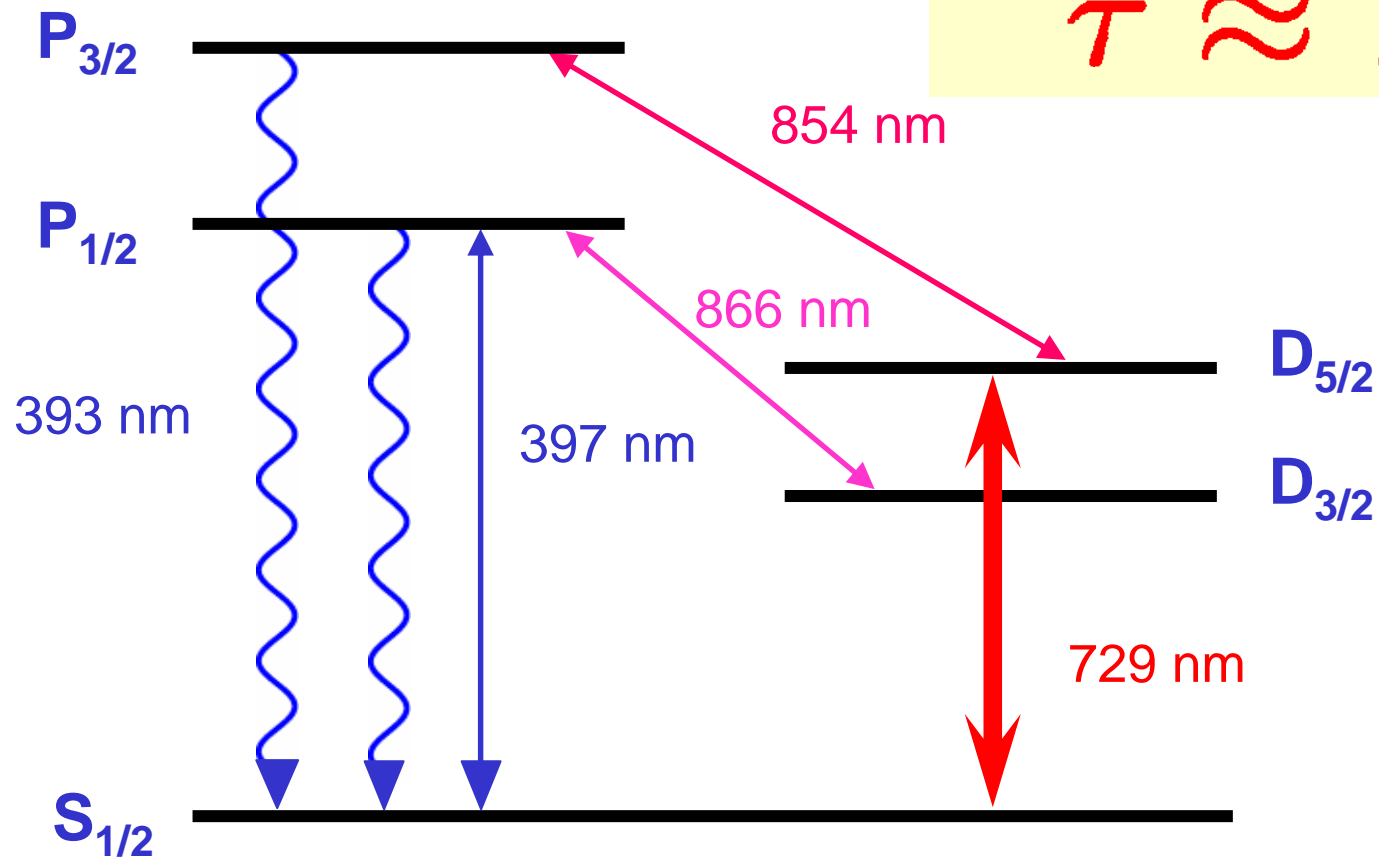

Quantized Ion Motion

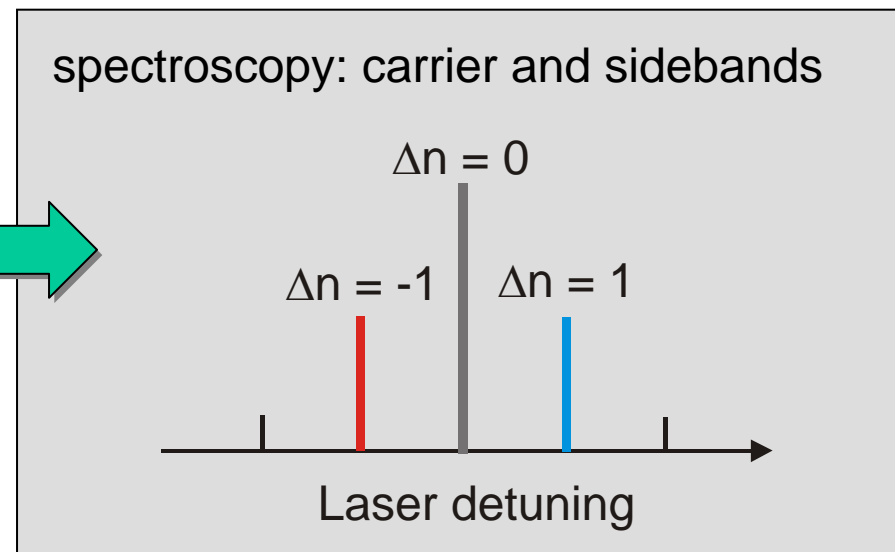
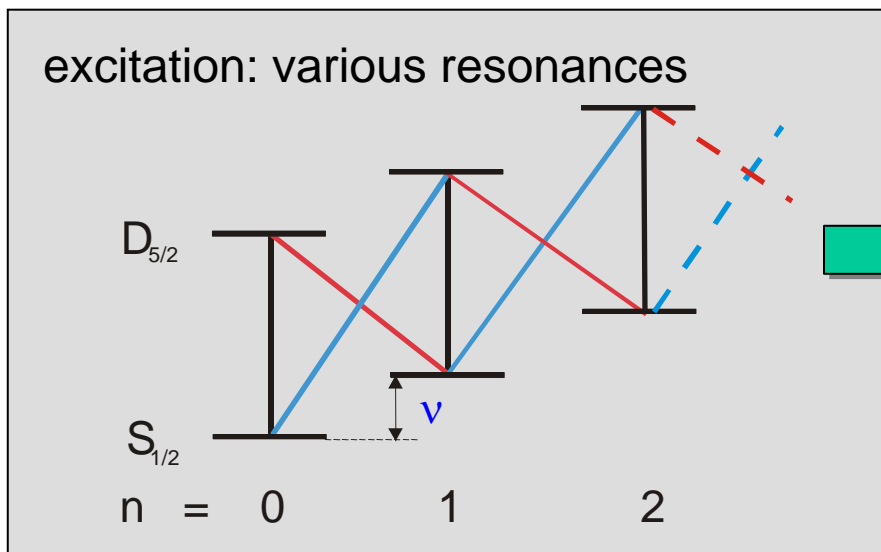
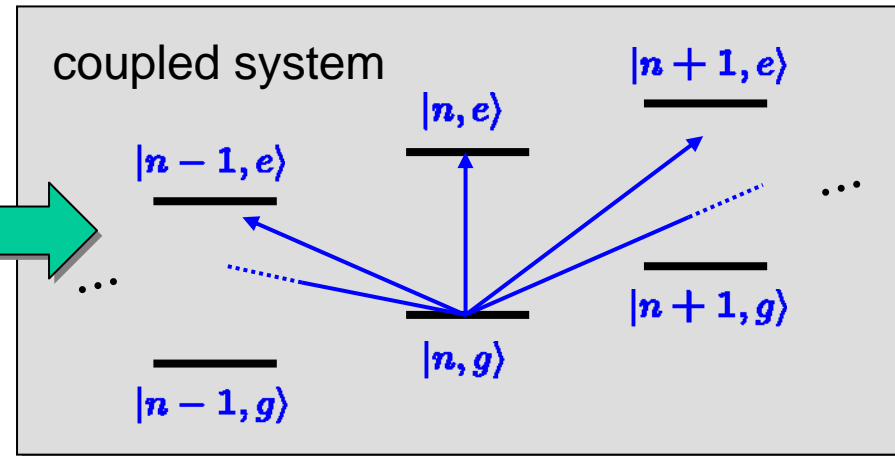
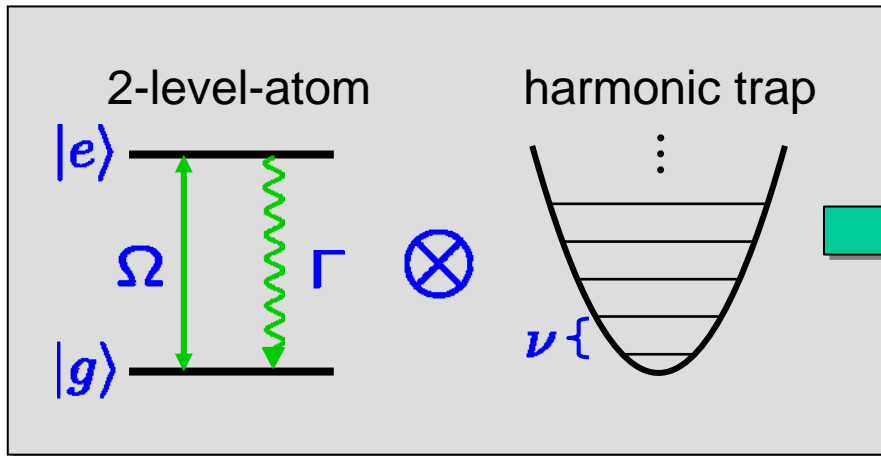

Excitation spectrum of single ion in linear trap

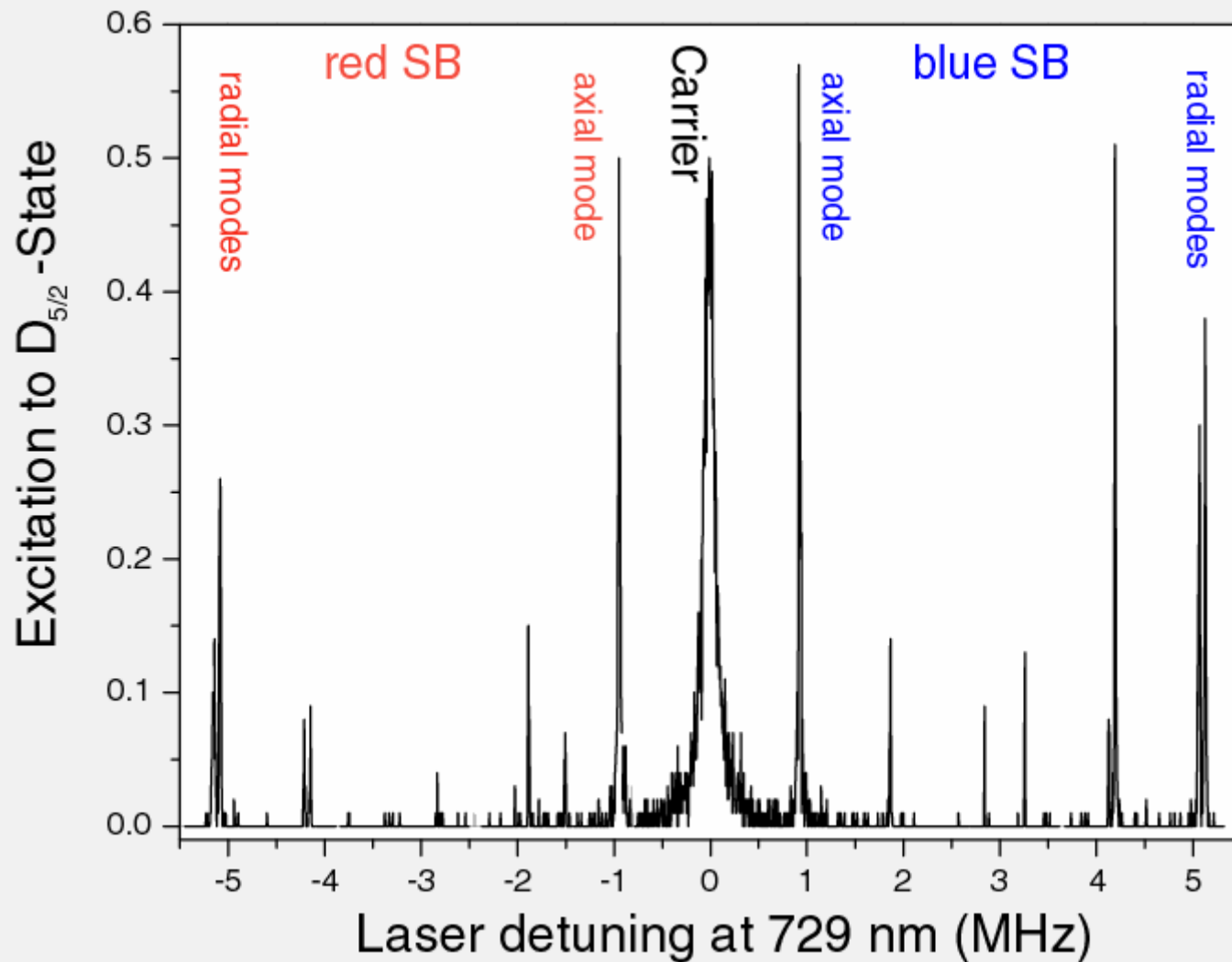

$$\omega_{\text{ax}} = 1.0 \text{ MHz}$$

$$\omega_{\text{rad}} = 5.0 \text{ MHz}$$

Addressing of individual ions in a linear Paul trap

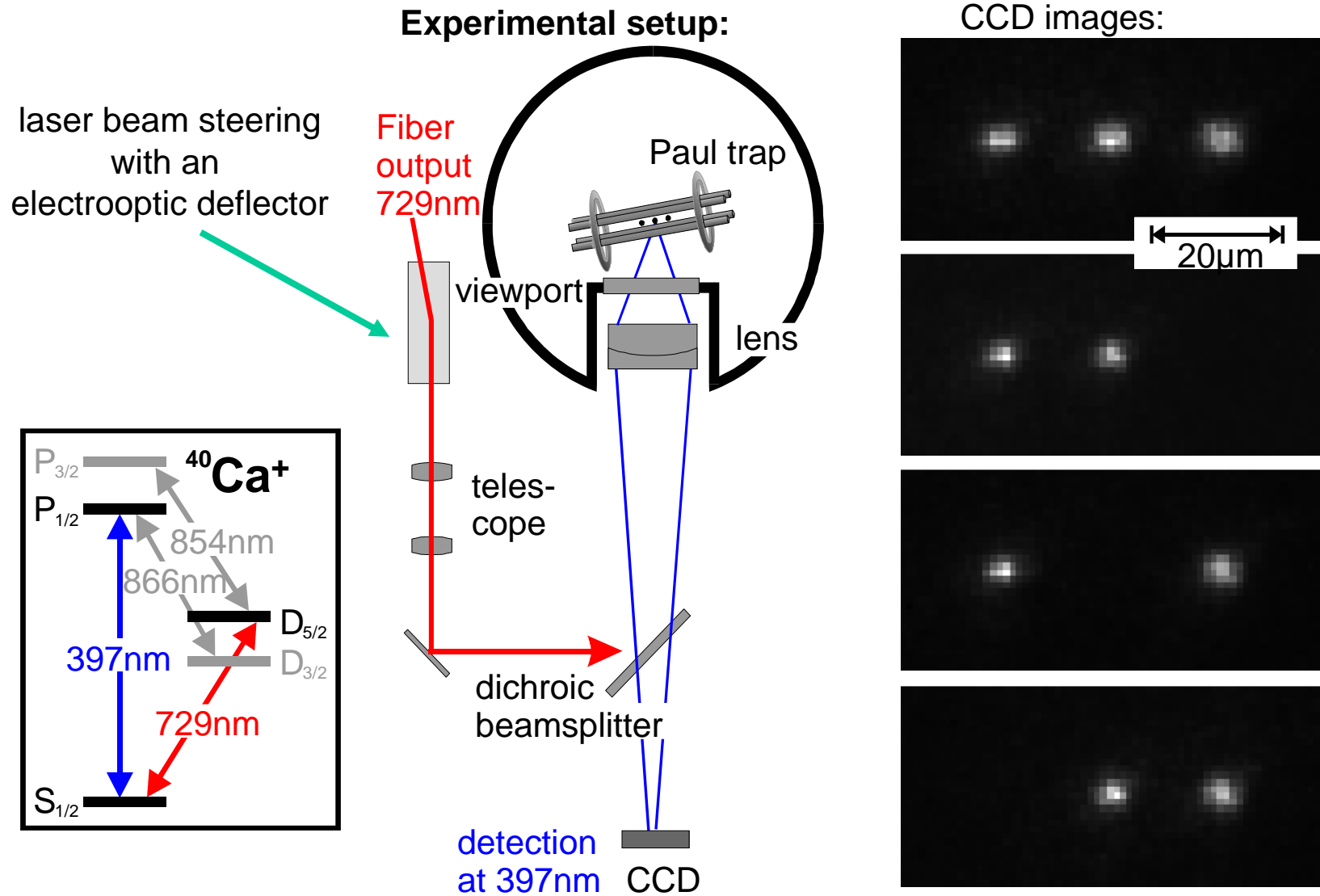

H.C. Nägerl et al., Phys. Rev. A **60**, 145 (1999)

Spectroscopy with quantized fluorescence (quantum jumps)

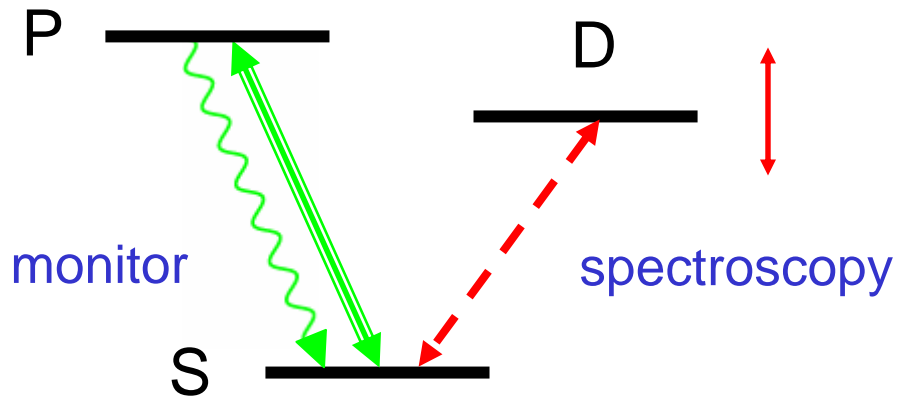

absorption and emission cause fluorescence steps (digital quantum jump signal)

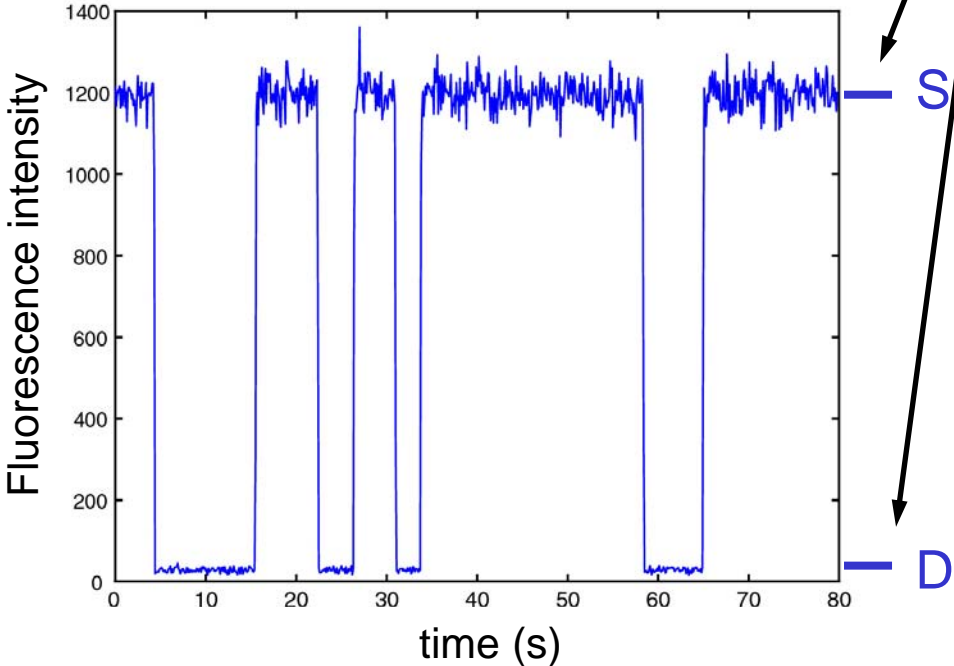

detection efficiency:
99.85%

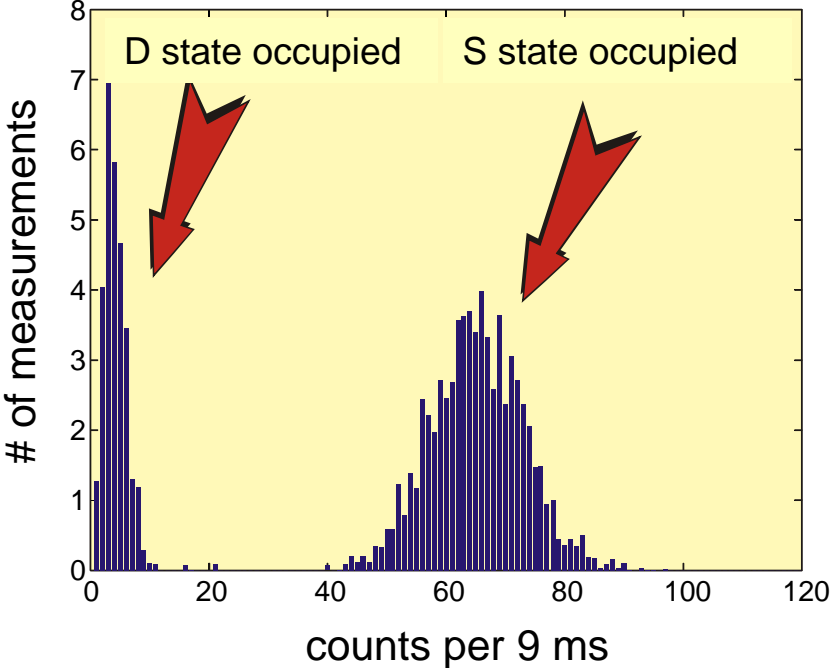

Coherent state manipulation

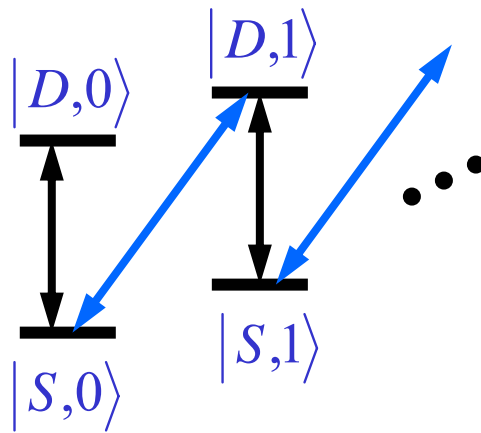

carrier and sideband
Rabi oscillations
with Rabi frequencies

$$\Omega, \quad \eta\Omega\sqrt{n+1}$$

$\eta = kx_0$ Lamb-Dicke parameter

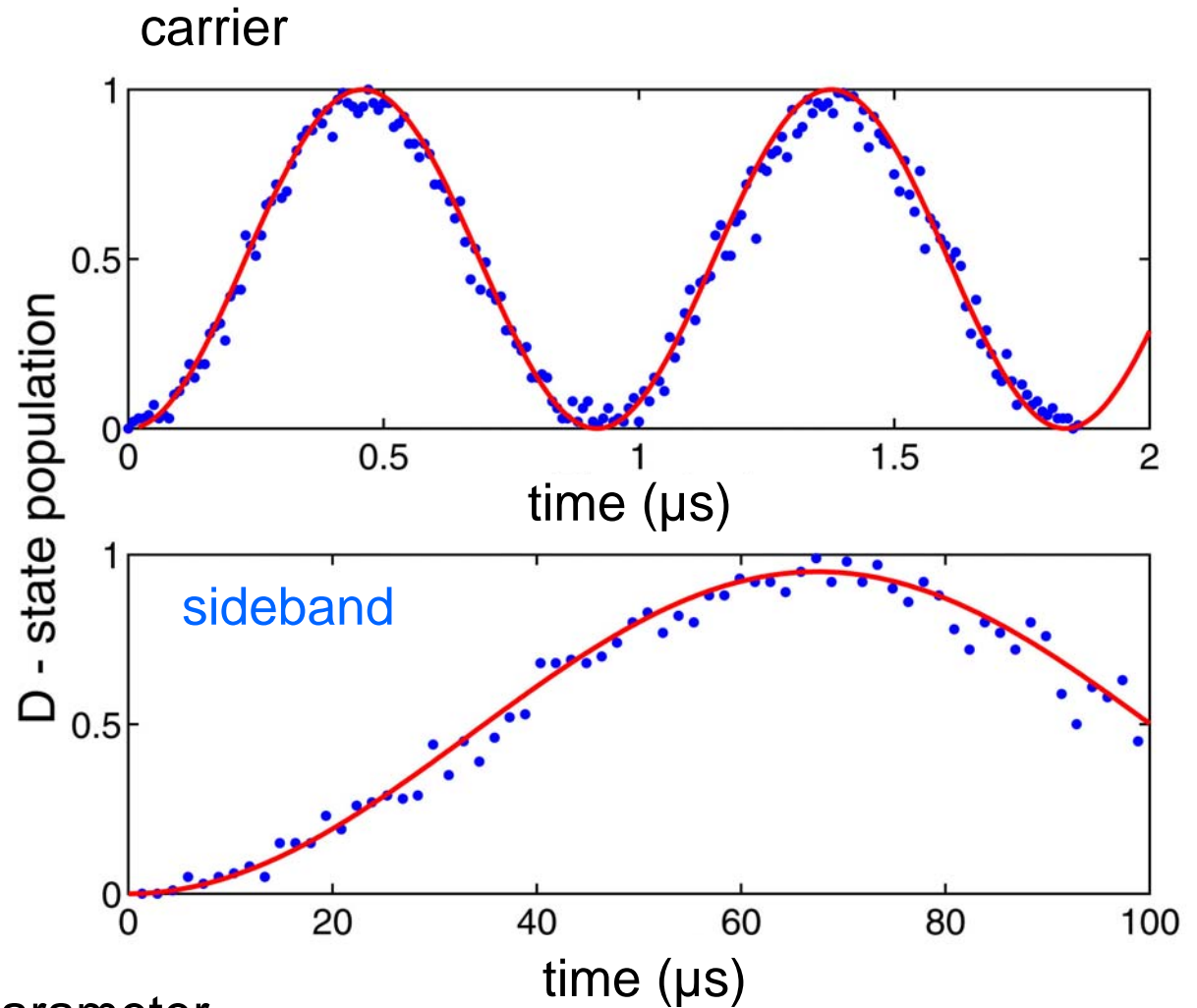

Scaling the ion trap for quantum computing

- more ions, larger traps, phonons carry quantum information
Cirac-Zoller, slow for many ions (few 10 ions maybe possible)
- move ions, carry quantum information around

Kielinski et al.,
Nature **417**, 709 (2002)

requires small,
integrated trap structures,

miniaturized optics
and electronics

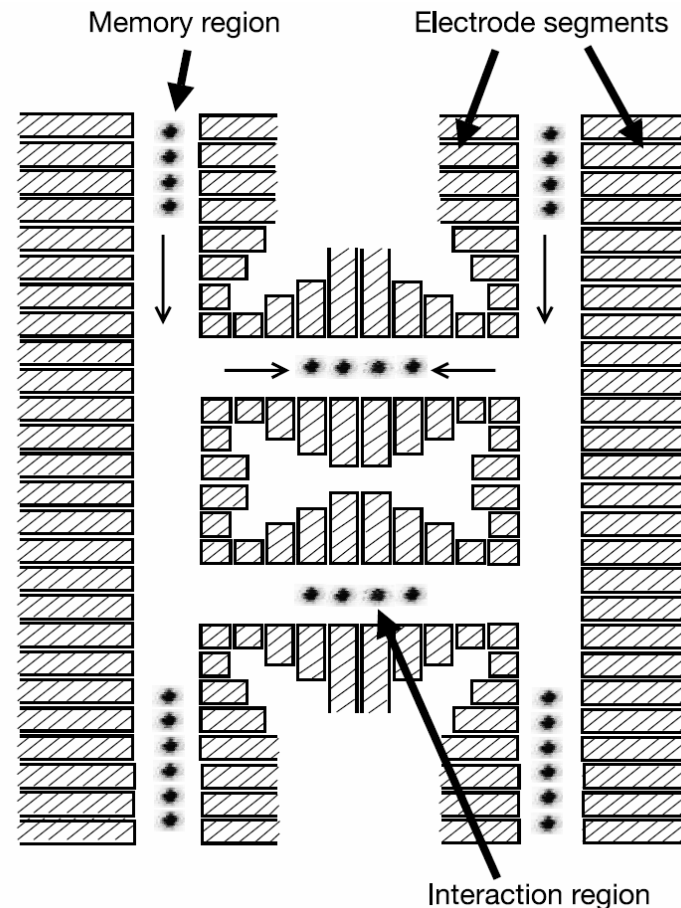

Innsbruck segmented chip trap (2005)

- assembly as sandwich on chip carrier

